

REV	DESCRIPTION	DESIGN	DATE
A0	NEW RELEASE	Wudanping	2014/09/27
A1	Adjust flatness	Jiangjianyin	2020/06/18

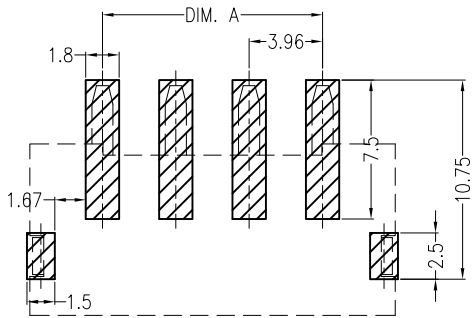
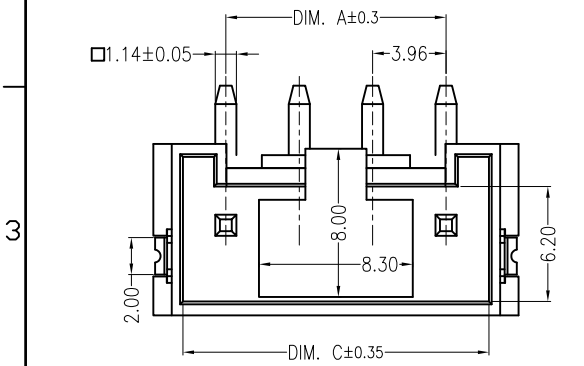
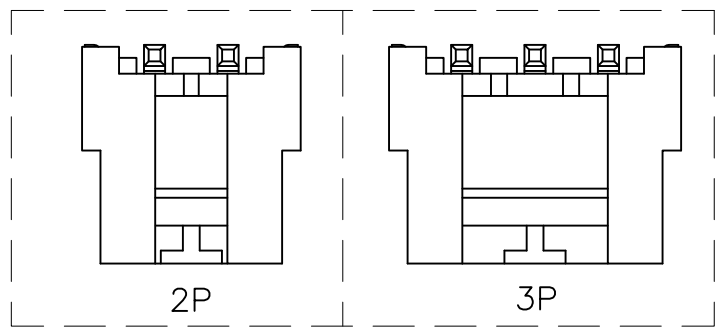
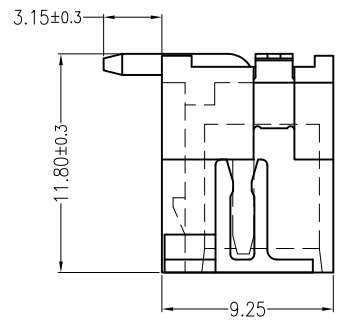
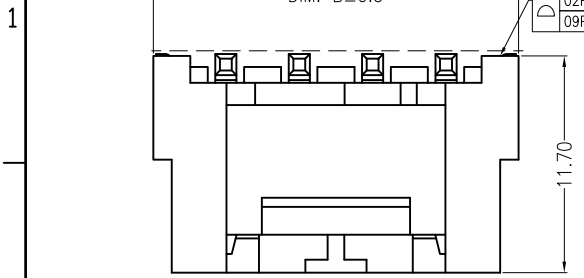

Specifications:

- Contact resistance: $\leq 20m\Omega$
- Insulation resistance: $\geq 1000M\Omega$
- Rated voltage: 250V AC DC
- Rated current: 7.0A AC DC
- Withstand voltage: 1500V AC/minute
- Temperature range: $-25^{\circ}C \sim +105^{\circ}C$
- Housing: PA9T, UL94V-0, Natural
- Cap: PA9T, UL94V-0, Natural
- Contacts: Brass/Sn
- Solder tabs: Phosphor Bronze/Sn

ORDER INFORMATION:

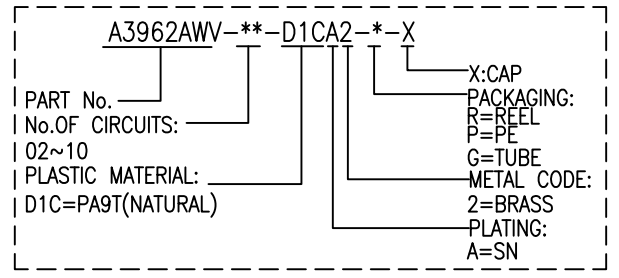

Circuits	Dimensions (mm)		
	DIM. A	DIM. B	DIM. C
02	3.96	11.88	8.60
03	7.92	15.84	12.56
04	11.88	19.80	16.52
05	15.84	23.76	20.48
06	19.80	27.72	24.44
07	23.76	31.68	28.40
08	27.72	35.64	32.36
09	31.68	39.60	36.32
10	35.64	43.56	40.28
*11	39.60	47.52	44.24
*12	43.56	51.48	48.20
*13	47.52	55.44	52.16
*14	51.48	59.40	56.12
*15	55.44	63.36	60.08
*16	59.40	67.32	64.04

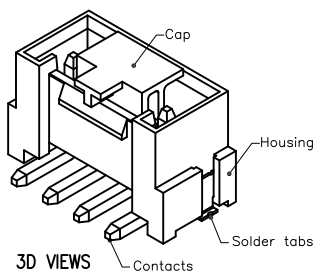
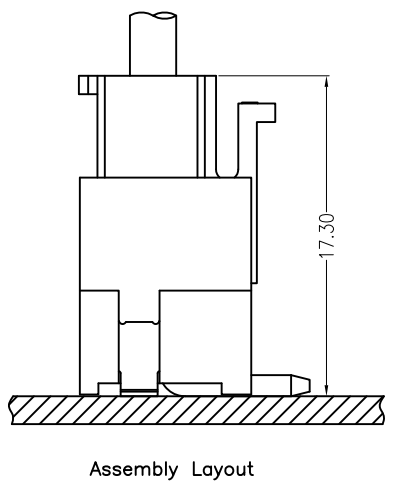

JKUN 温州健坤接插件有限公司 WENZHOU JKUN CONNECTOR CO.,LTD.		TITLE: 3.96mmPITCH 180°WAFER SMT TYPE	
GENERAL TOLERANCE		USE:	PART NO.:
X. ±0.50	X. ±5'	CUSTOMER	A3962AWV-**-D1CA2-*-X
X.X ±0.30	X.X ±2'	APPD: Shaojinghe	DWG NO.:
X.XX ±0.20	X.XX ±1'	CHKD: Zenglingqing	JKUN/GCKH-0577
UNITS: mm		DR: Jiangjianyin	SCALE
			1 : 1
			SHEET
			1 / 1